

## 23cm Panel Antennas

**By Paul Melbourne G8GML and Ian Waters G3KKD.**

This article describes a range of panel antennas developed by G8GML. It is a sequel to an article by John Stockley, G8MMY, published in CQ-TV 180. His article described a panel antenna with a single bay of 4 loops and a gain of 12dB, which he suggested as suitable for portable use.

The antennas described in this article are based on similar principles, with 1, 2, 4 and 8 bays, each of 6 loops, intended mainly for fixed station use. They are used extensively by members of the Cambridge (GB3PV) ATV group. The results are excellent and definitely superior to long Yagis.

These antennas are similar in principle to those described in the UHF Compendium, but with a slightly different design. They employ 6 loops with a larger aspect ratio, which permits a higher stacking gain.

The family of panel antennas consists of:

- 1 bay of 6 loops .gain 16 dBd.
- 2 bays of 6 loops .gain 19 dBd.
- 4 bays of 6 loops .gain 22 dBd.,
- 8 bays of 6 loops .gain 25 dBd.

Accepting that absolute gain measurements are difficult to perform, the gains of the 2 and 4 bay panels have been arrived at by comparing the signal received from a distant beacon using these panels, with that received using two reference antennas. The reference antennas employed were a circular waveguide antenna and a DL6WU 43 element very long Yagi. These are said to have gains of 8 and 17dBd respectively. While the absolute gains of these two references could not be checked, it was encouraging that the gain difference between them was 9dB as it should be. In fact during the tests a total of 11 antennas of various types by various makers were measured. The beacon signal was received by reflection from a huge aircraft hangar, which helps to overcome ground reflections, and Fresnel zone problems. The gains of the 1 and 2 bay panels were not checked but it may be expected that they have the figures given.

These panels are stable in all weather conditions whereas Yagis tend to de-tune when wet or covered in frost.

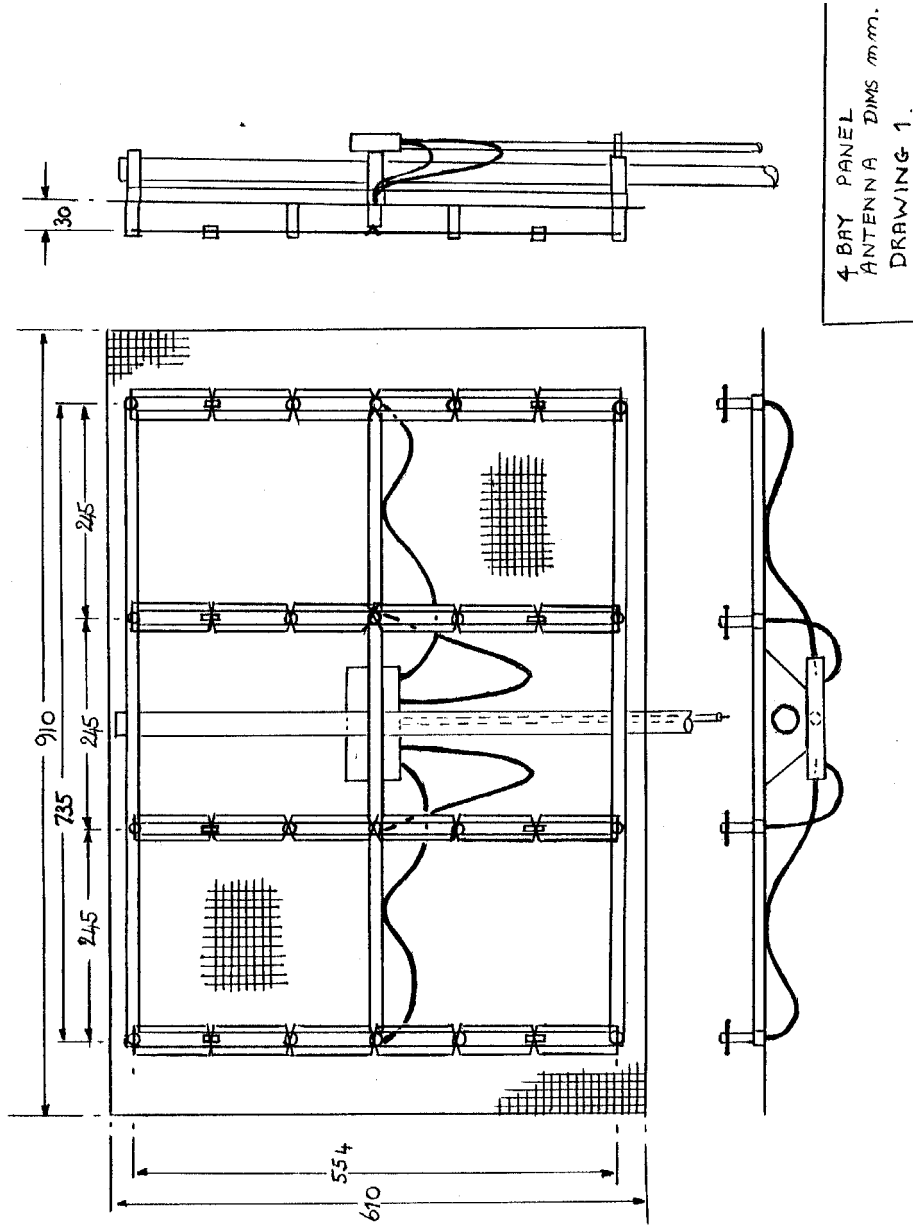

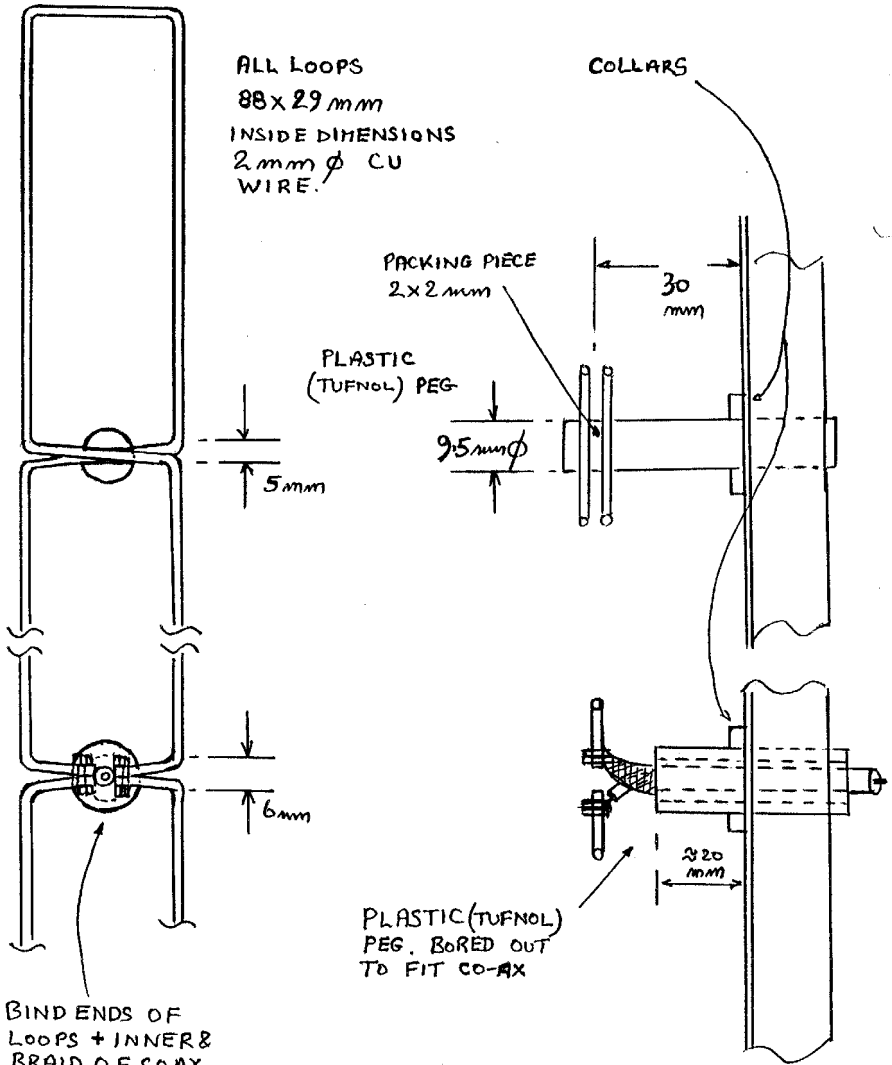

23 CM PANEL ANTENNAS  
DETAIL OF LOOPS, SUPPORTS  
AND FEEDER CONNECTION.  
DRAWING 2.

## Construction

The following is a description of a panel antenna with 4 bays each of 6 loops in front of a mesh reflector constructed by O3KKD and in use at his QTH. It has a gain, arrived at as described above, of 22dBd.

The 4 bay antenna, in common with all versions, employ a mesh for the reflector, sheets of which may be obtained from garden centres. These sheets are each 3 x 2 ft, they are plated and have a mesh size of about 1/2 x 1/2 inch.

The design for the 6 loop x 4 bay panel is shown in drawing 1. The reflector mesh is supported on a framework made from 15mm square section aluminium tube or perhaps hardwood. Joints are reinforced by gusset plates. It will be seen that a vertical support member is positioned behind each bay of loops to give support for the radiating elements. For smaller panels the design is reduced in width as required. The panel is supported on the pole by 3 brackets bolted to the horizontal frame members and bored out to clamp on the pole. This gives a very rigid structure.

Drawing 2 shows the construction of the radiating loops which are made of 2mm diameter copper wire. Each loop has internal dimensions of 88 x 29mm. This loop geometry gives an impedance of 33ohms. There are 6 loops in each vertical row, with 3 above and 3 below the feed point. Three 33ohms in series gives 100ohms and the two halves of the row in parallel give a feed point impedance of 50ohms.

The top and bottom of each row together with the cross points, 2 and 4 are supported on plastic pegs which fit into holes in the support frame. Crossover points 1 and 5 are not supported, but the crossovers are insulated using spacers as shown in drawing 3.

The distribution feeders, which use 5mm OD 50ohm coax, pass through pegs similar to those described above, but bored out to just clear the cable. These are made shorter to allow the cable inner and braid to be separated and connected to the loops. They are bound with wire and then soldered. In the 3KKD version Tufnol has been used for the pegs, which were provided with collars, which rest on the front face of the reflector. Other materials probably hardwood could perhaps be used. The pegs are retained in the frame by gluing and the distribution cables are retained inside their pegs using Isopon resin, which seems to be very resistant to the weather.

All cross over, support and connection points are also covered with several coats of Isopon.

## 23cm Panel Antennas

### DETAIL OF NON-SUPPORTED LOOP CROSS OVER

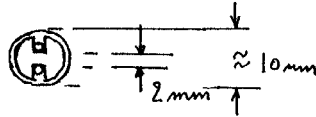
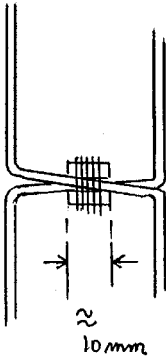

PLASTIC PEG WITH SLOTS  
CUT ON 2 SIDES, BIND WITH  
STRING & SEAL WITH ISOPON

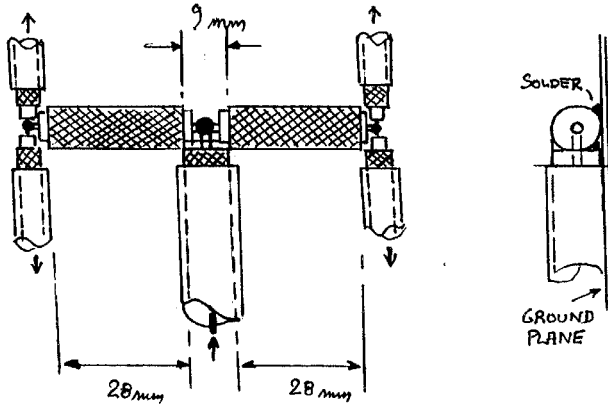

ALL CABLES ARE 50Ω  
BRAIDS SOLDERED TO  
GROUND PLANE  
ALL DISTRIBUTION  
FEEDERS IDENTICAL LENGTH

2, 50Ω DISTRIBUTION FEEDERS IN  
PARALLEL = 25Ω, 2 MATCHING  
TRANSFORMERS NEED TO BE 100Ω  
TO CONNECT IN PARALLEL TO  
MAIN FEEDER ∴ ZT =  $\sqrt{25 \times 100}$   
= 50Ω.

### DETAIL OF POWER SPLITTER FOR 4 BAY PANEL ANTENNA

#### DRAWING 3.

The distribution feeders, which must all be of exactly the same length, connect to the power splitter contained in a sealed box mounted on the rear side of the pole. A small drain hole is a good idea. For correct phasing it is important that the centres of the coaxes all go to the same sides of the loops. The power splitter for the 4 bay panel is shown in drawing 3. It takes the form of a T splitter made from two 28mm lengths of 50ohm

cable. All cable braids are soldered down to a ground plane. For weather protection all cables enter and leave by the bottom of the box, with those distribution feeders shown on drawing 3 going upward being turned inside the box to leave through the bottom.

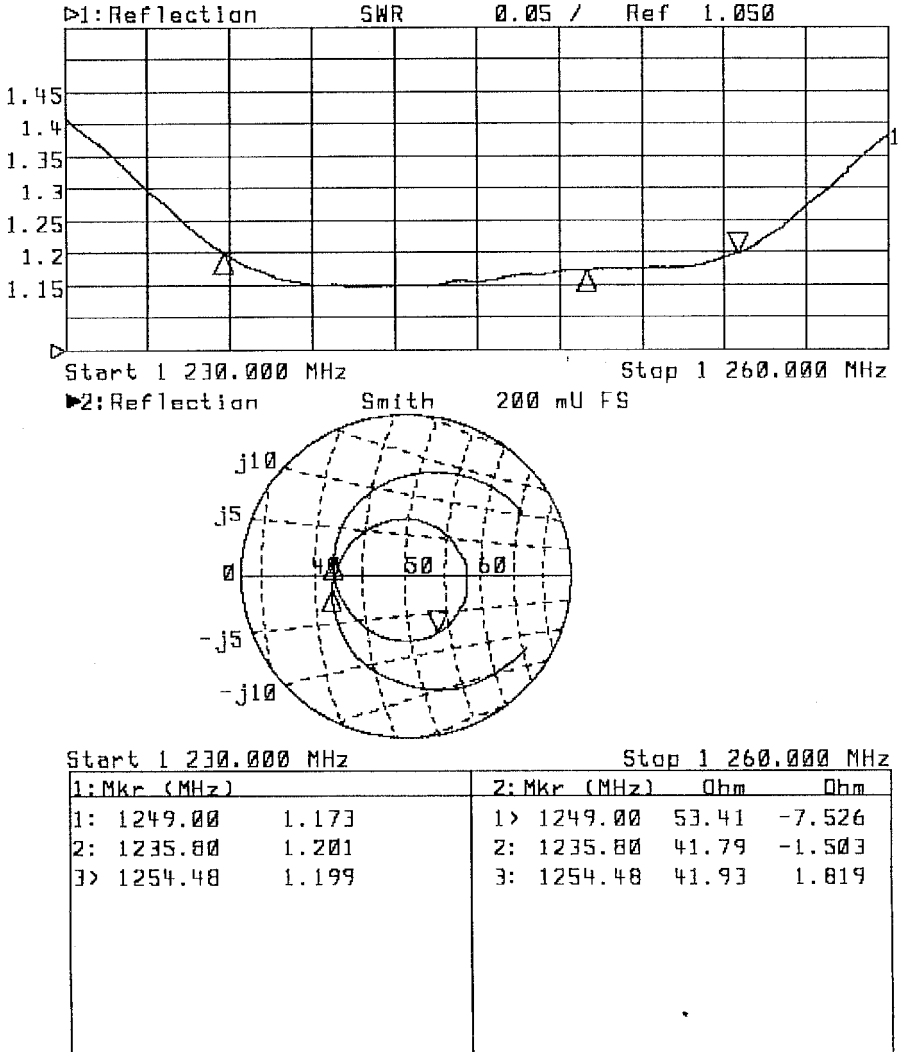

DRAWING 4

## Power Distribution for 1 and 2 Bay Panels

As the feed impedance of a single bay of loops is 50ohms, no matching or distribution arrangements are necessary. For a 2 bay panel a power splitter similar to that shown in drawing 3 is used, except that the arms of the T are made from 70ohm cable and only one 50ohm distribution feeder is connected to each outer end. Drawing 4 shows the VSWR of the 2 bay panel used by C6FKS as measured by G1TFK.



### 8 Bay Panel

An 8 bay panel has been constructed and is in use at G8GML. This is shown in drawing 5. It consists of two 4 bay panels, as described above, mounted one above the other. This increases the gain by reducing the width of the vertical radiation pattern, while keeping the horizontal pattern similar. The spacing between the bottom of the top row of loop and the top of the bottom loop is 76mm. The horizontal spacing between the rows of loops has also been increased from 245mm centre to centre to 305mm.

The power distribution arrangement uses two 4-way splitters, similar to those used with the 4 bay panel, in turn fed by a 2-way splitter as used with the 2 bay design. The feed arrangements have been changed to be as shown in drawing 5 with bays 1, 2, 5 and 6 fed by one splitter, while bays 3, 4, 7 and 8 are fed by the other.

The gain of this large panel has been measured as 25dBd, so if fed from a Mitsubishi brick, with say 15W output and allowing a 1dB feeder loss, an

## *23cm Panel Antennas*

ERP of 3.76kW may be obtained. This certainly puts a good noise free picture into the Cambridge GB3PV repeater. As this gain is similar to that of an 8ft parabolic dish, the antenna could be considered for EME communication! It is very much easier to make and less expensive than a dish.





23cm Panel Antennas

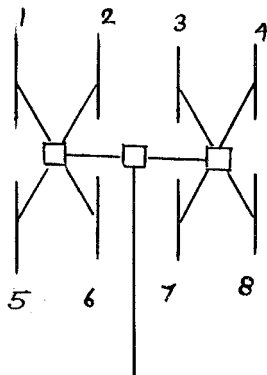
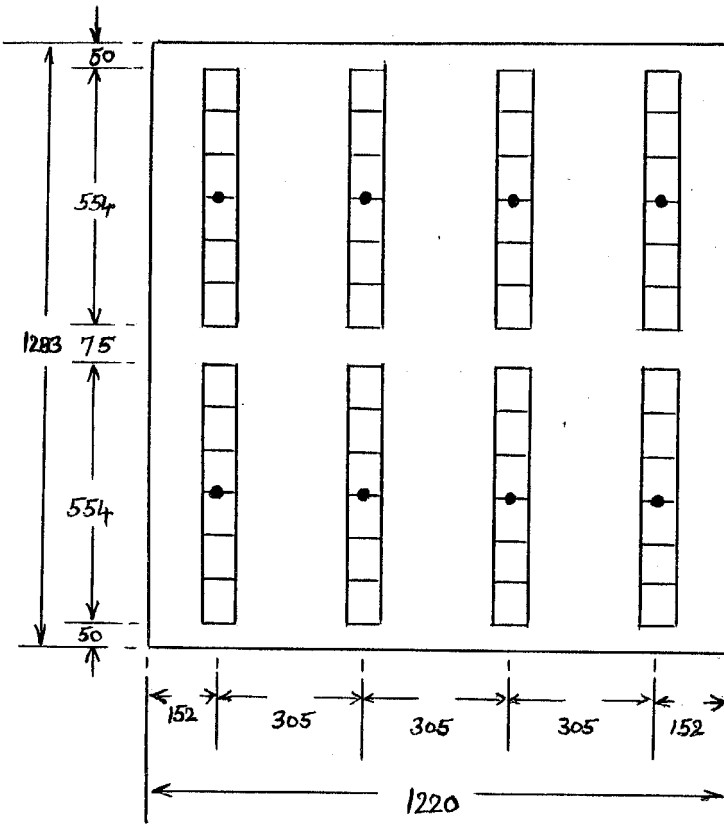

8 BAY PANEL ANTENNA  
 & FEEDING SYSTEM  
 DIMENSIONS IN mm  
 DRAWING 5